

HERE ARE THE ASSEMBLY INSTRUCTIONS FOR YOUR TOY. YOU CAN ALSO CUT OUT THE PAGE AND FILE IT IN A FOLDER, THEN YOU CAN ALWAYS BUILD YOUR TOY AGAIN LATER.

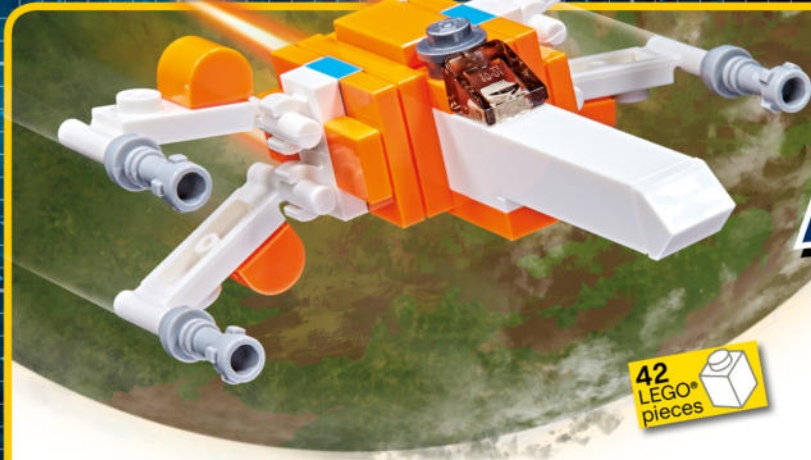

RESISTANCE X-WING

42
LEGO®
pieces

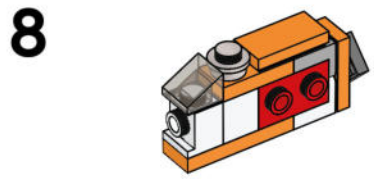
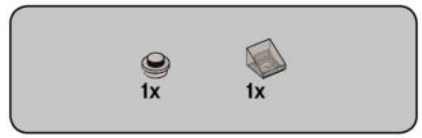
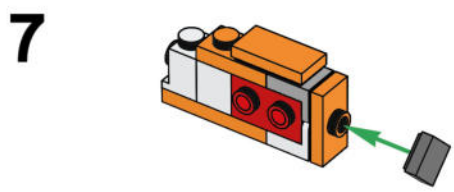
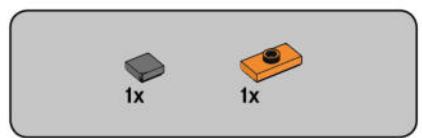
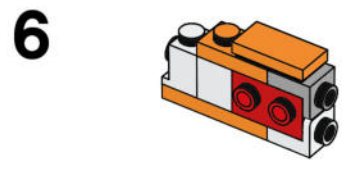
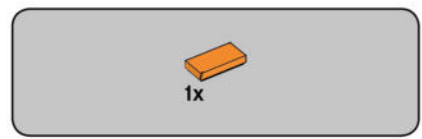
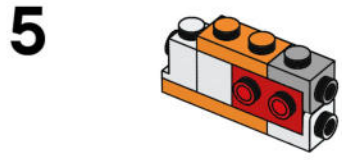
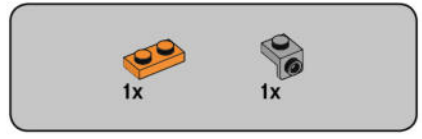
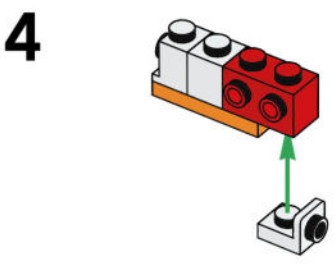
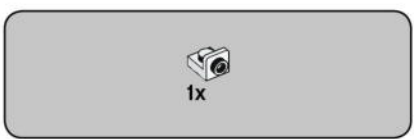
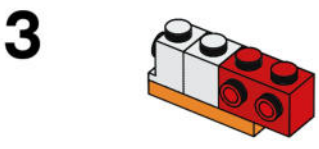
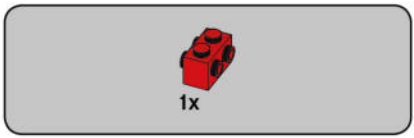
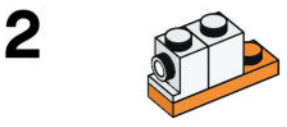
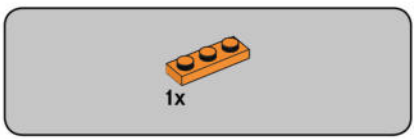
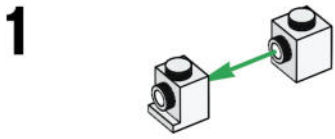
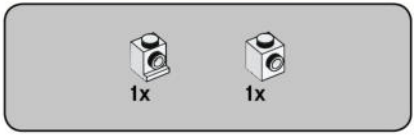

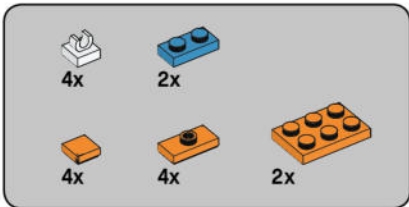
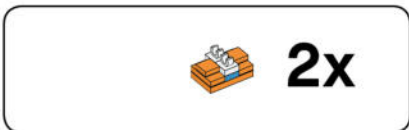
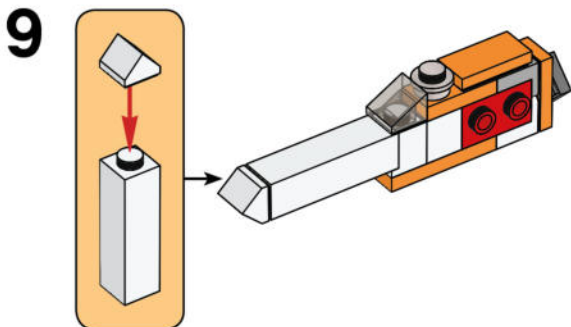
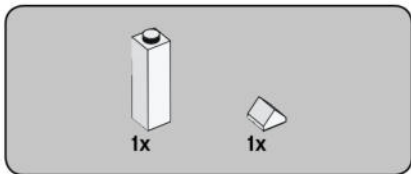

10

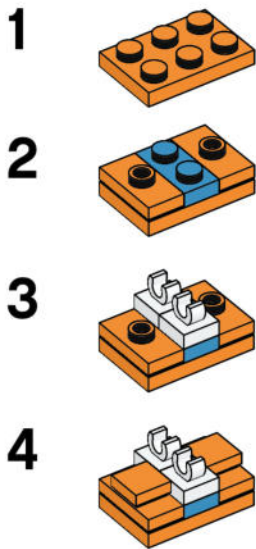

2x

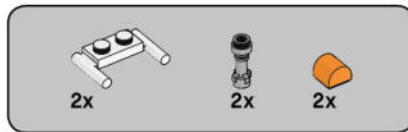
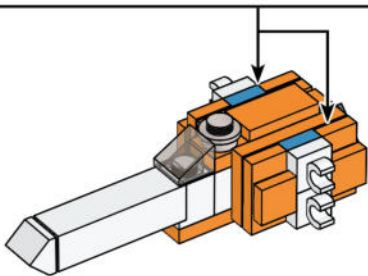

11

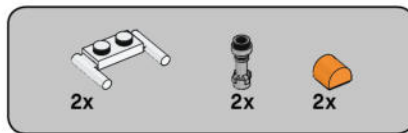
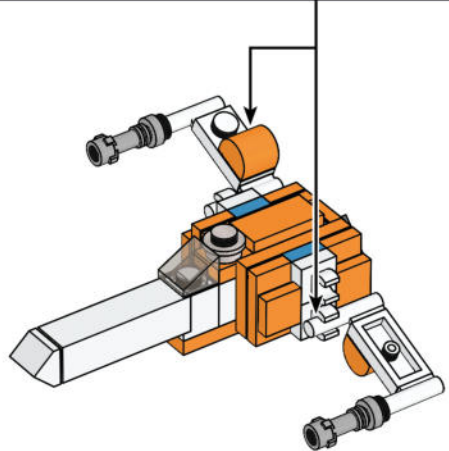
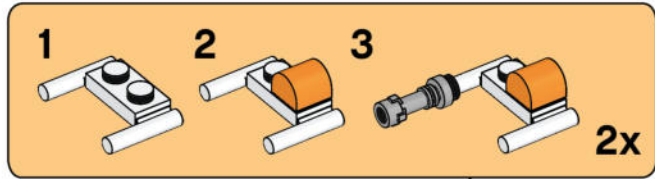

12

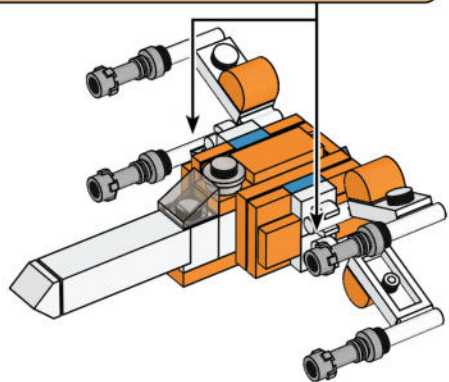
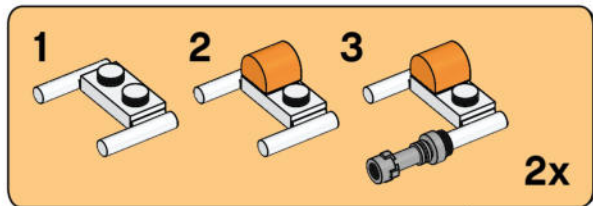

After you have assembled your Resistance X-wing™, it will need a shelter. So why not build a hangar for it with your LEGO® bricks, then the First Order won't be able to find it!